

FAIRLAND®
TurboSilence 20

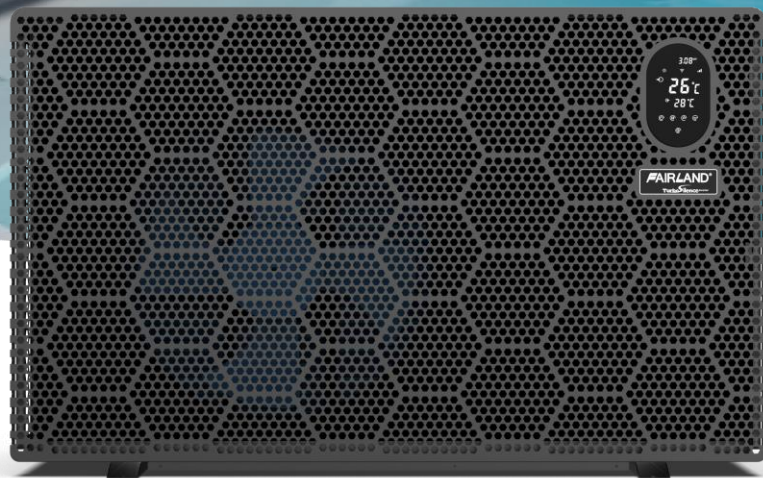

welldana®
● ● ●

EN/NL/FR

SUMMARY

FOR USERS P.3-P.12

1. GENERAL INFORMATION	3
1.1. Contents	3
1.2. Operating conditions and range	3
1.3. Advantages of different modes	4
1.4. Kind reminder	4
2. OPERATIONS	6
2.1. Notice before using	6
2.2. Operation instructions	6
2.3. Advanced application	8
2.4. Daily maintenance and winterizing	10
3. TECHNICAL SPECIFICATION	11

FOR INSTALLERS AND PROFESSIONALS P.13-P.29

1. TRANSPORTATION	13
2. INSTALLATION AND MAINTENANCE	13
3. TROUBLE SHOOTING FOR COMMON FAULTS	19
4. FAILURE CODE	20
APPENDIX 1: HEATING PRIORITY WIRING DIAGRAM (OPTIONAL)	21
5. WI-FI SETTING	22
CE Declaration of conformity	29

PLEASE READ IT CAREFULLY AND KEEP IT FOR SUBSEQUENT USE

This manual provides you necessary information for optimal use and maintenance

This appliance is not intended for use by persons (including children) with reduced physical, sensory or mental capabilities, or lack of experience and knowledge, unless they have been given supervision or instruction concerning use of the appliance by a person responsible for their safety.



- a. Please read the following tips before installation, use and maintenance.
- b. Installation, removal and maintenance must be carried out by Professional in accordance with the instructions.
- c. Gas leakage test must be done before and after installation.

1. Use

- a. It must be installed or removed by professionals, and it is forbidden to dismantle and refit without permission.
- b. Don't put obstacles before the air inlet and outlet of the heat pump.

2. Installation

- a. This product must be kept away from any source of fire.

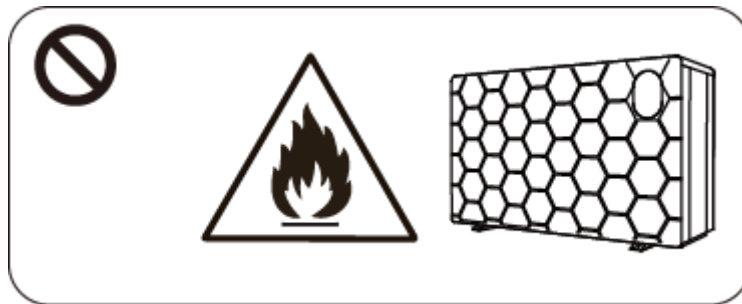

- b. The installation can't be in a closed environment or indoors, and must be kept well ventilated.

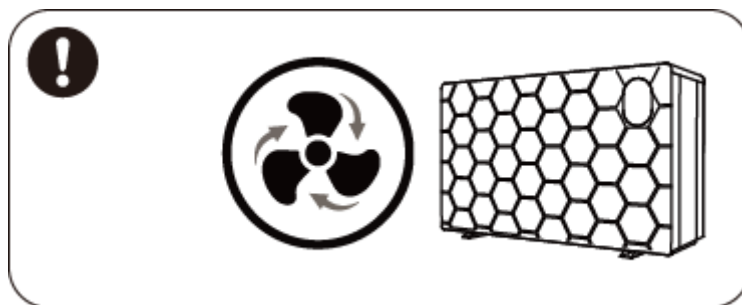

- c. Vacuum completely before welding, field welding is not allowed, welding can only be performed by professional personnel in professional maintenance center.

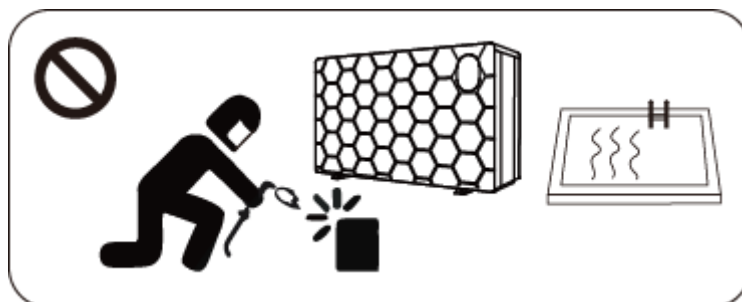

- d. Installation must be stopped if any gas leakage, and the unit must be returned to professional maintenance center.

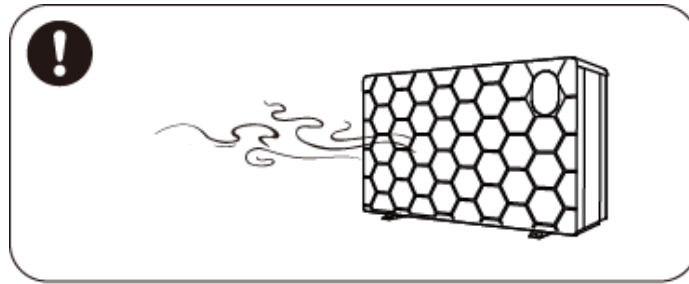

3. Transportation and Storage

- a. Sealing is not allowed during transportation
- b. Transporting goods at a constant speed is needed to avoid sudden acceleration or sudden braking, so as to reduce the collision of goods.
- c. The unit must be far away from any source of fire.
- d. Storage place must be bright, wide, open and good ventilation, ventilation equipment is required.

4. Maintenance Notice

- a. If maintenance or scrap is required, contact an authorized service center nearby
- b. Qualification requirement
All operators who dispose gas must be qualified by valid certification which issued by professional agency.
- c. Please strictly comply with the requirement from manufacturer when maintenance or filling gas. Please refer to the technical service manual.

1. GENERAL INFORMATION

1.1. Contents

After unpacking, please check if you have all the following components.

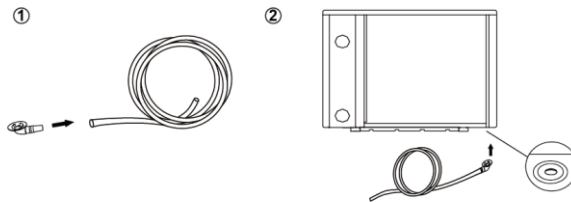
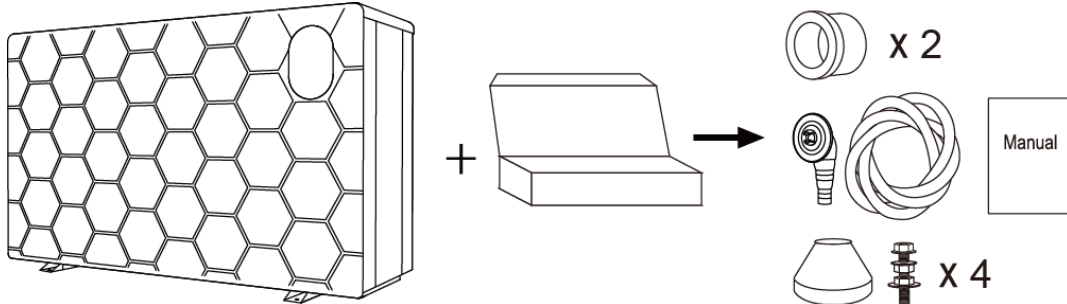

NOTICE:

Please install the water unions step by step.

STEP 1

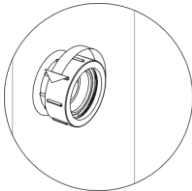

STEP 2

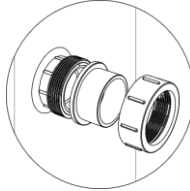

STEP 3

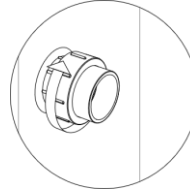



1.2. Operating conditions and range

ITEMS		RANGE
Operating range	Air temp	-20°C~43°C
Temp. setting	heating	18°C~40°C

The heat pump will have ideal performance in the operation range Air 15°C~25°C.

1.3. Advantages of different modes

The heat pump has three modes: Turbo, Smart and Silence. They have different advantages under different conditions.

MODE	ADVANTAGES
Turbo mode 	Heating capacity: 120%~20% Fast heating, intelligent optimization according to ambient temperature and water temperature Energy efficiently saving
Smart mode 	Heating capacity: 100%~20% Intelligent optimization according to ambient temperature and water temperature Energy efficiently saving
Silence mode 	Heating capacity: 60%~20% Use at night

1.4. Kind reminder

 In case of power failure during the operation of the machine, the machine will automatically restart when the power is restored.

1.4.1. The heat pump can only be used to heat the pool water. It can NEVER be used to heat other flammable or turbid liquid.

1.4.2. Don't lift the water unions when moving the heat pump since the titanium heat exchanger inside the heat pump will be damaged.

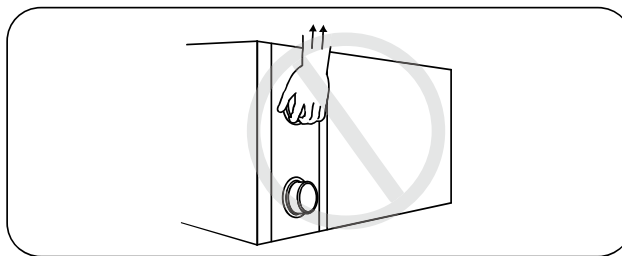

1.4.3. Don't put obstacles before the air inlet and outlet of the heat pump.

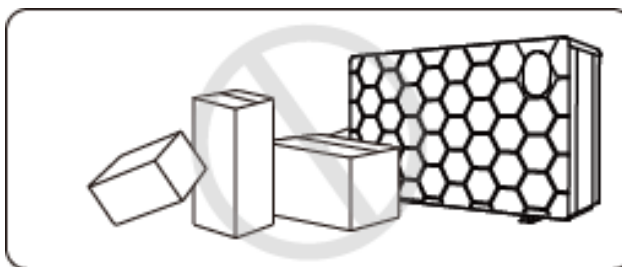

FOR USERS

1.4.4. Do not put anything into the inlet or outlet, and do not remove the fan cover and the running fan to avoid injury.

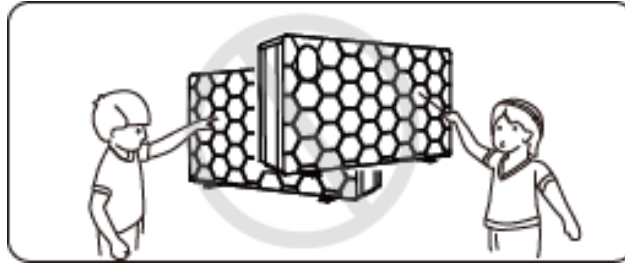

1.4.5. Don't use or store combustible gas or liquid such as thinners, paint and fuel to avoid fire.

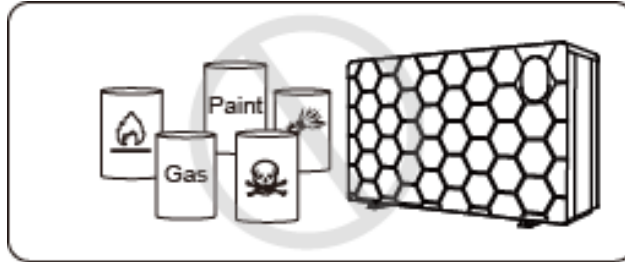

1.4.6. If any abnormal circumstances occurred, e.g.: abnormal noises, smells, smokes and leakage of electricity, switch off the main power immediately and contact your local dealer. Don't try to repair the heat pump by yourselves.

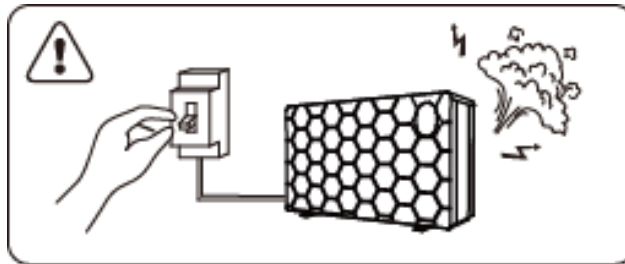

1.4.7. The main power switch should be out of the reach of Children.

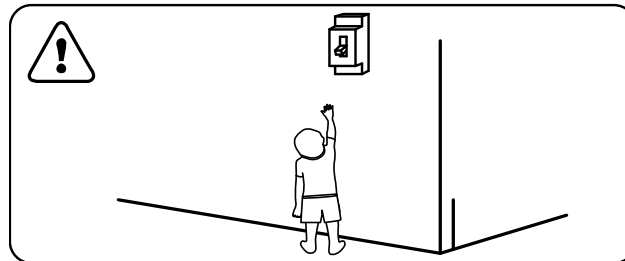

1.4.8. Please cut off the power in the lightning storm weather.

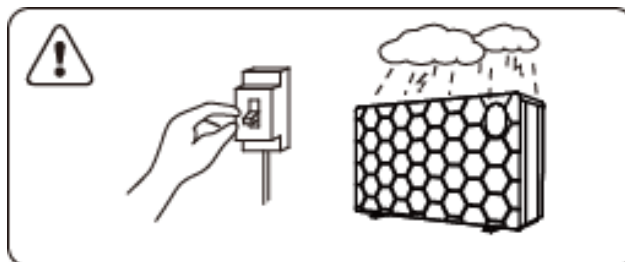

1.4.9. Please note that the following codes are not failure.

	CODES
No water protection	E3
Anti-Freezing Protection	Ed
Out of the operating range	Eb
Insufficient water flow protection	E6
Power abnormal	E5

2. OPERATIONS

2.1. Notice before using

- 2.1.1. For longer service life, please ensure water pump is on before heat pump starts to work, and water pump is off after heat pump is off.
- 2.1.2. Ensure no water leakage on piping system, then unlock screen and power on heat pump.

2.2. Operation instructions



SYMBOL	DESIGNATION	FUNCTION
	ON/OFF	1. Power On/Off 2. Wi-Fi setting
	Unlock	Press it for 3 seconds to unlock/lock screen
	Speed	Select Turbo/Smart/Silence mode

FOR USERS

	Up / Down	Adjust set temperature
---	-----------	------------------------

Note:  will be light all the time when power is on.

① Standby screen display:

When the screen is locked, the key lamp will be off.

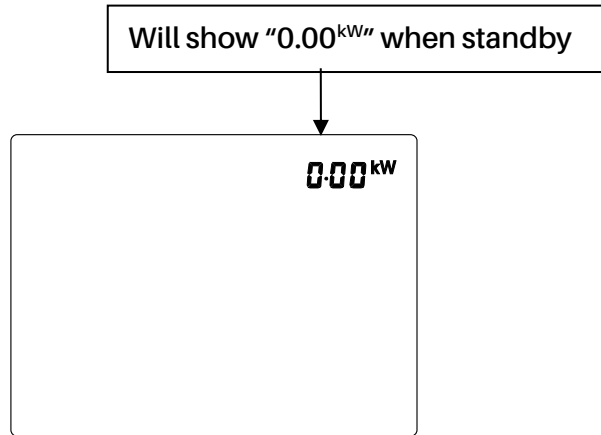





② Screen lock:

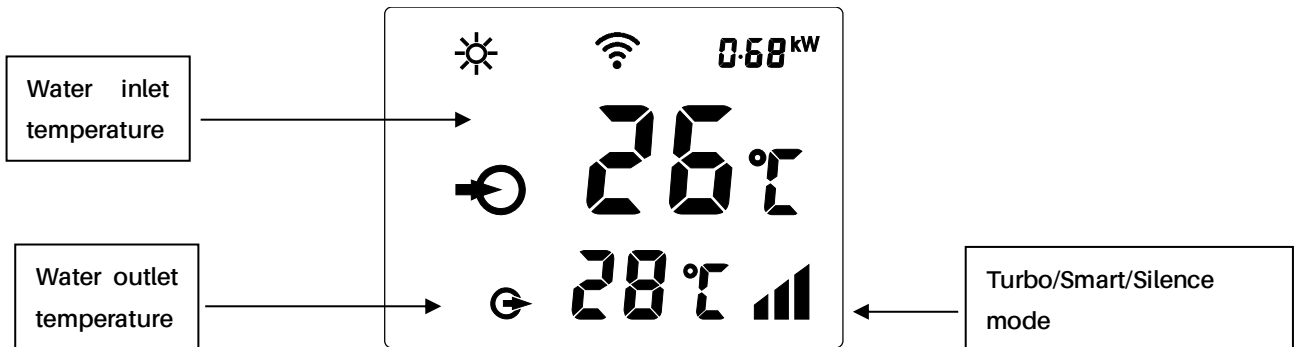

- a. If no operation in 30 seconds, screen will be locked.
- b. When HP is off, screen will be dark and "0%" or "0.00^{kW}" will be displayed.
- c. Press  for 3 seconds to lock screen and it will be dark.





















③ Screen unlock:

- a. Press  for 3 seconds to unlock screen and it will be lit up.
- b. Only after screen is unlocked, any other buttons can be functioned.







	Heating
 80%	Heating capacity percentage
0.68 ^{kW}	Real-time power consumption display
	Wi-Fi connection

	Water inlet
	Water outlet

1. Power On: Press  for 3 seconds to light up screen, then press  to power on heat pump.
2. Adjust Set Temperature: When screen is unlocked, press  or  to display or adjust the set temperature.
3. Switching of real-time power consumption and heating capacity percentage display: Press  and  5 seconds to switch between real-time power consumption display and heating capacity percentage display. Real-time power consumption function available for single-phase only.
4. Turbo/Smart/Silence mode selection:
Press  to enter Turbo mode, and screen shows , then press  to enter Silence mode, the screen shows . Press  again, the screen shows  and return to Smart mode.
5. Defrosting
 - a. Auto Defrosting: When heat pump is defrosting,  will be flashing. After defrosting,  will stop flashing.
 - b. Compulsory Defrosting: When heat pump is heating, press  and  together for 5 seconds to start compulsory defrosting, and  will be flashing. After defrosting,  will stop flashing.
Note: Compulsory defrosting intervals should be more than 30 minutes and the compressor should run for more than 10 minutes at heating mode.
6. Temperature display conversion between °C and °F:
Press "" and "" together for 5 seconds to switch between °C and °F.
7. Wi-Fi setting
Please kindly check the last page.





2.3. Advanced application

2.3.1. Parameter Checking

- a. Press  and  together for 5 seconds to enter "Parameter Checking" status, the parameter code "P0" and the parameter value "0" will display on the screen, such as "P0 0", which means water pump running way is continuous.
- b. In "Parameter Checking" status, press  or  to check the parameters.

2.3.2. Parameter Modification





In "Parameter Checking" status, press  to enter the "Parameter Modification" mode,

press  or  to change the values, then press  to confirm and quit "Parameter Modification" mode, press  to quit "Parameter Checking" status.

2.3.3. Parameter list

NO.	Content	Adjust range	Step length
P0	Water Pump Running Way	0: Continuous 1: Water temp control 2: Time/water temp control	1
P1	Time Setting (Only available when the water pump running way is set to "2")	10 ~ 120 min	5 min
P2	Compressor Continuously Running Time between Defrosting Mode	30 ~ 90 min	1 min
P3	Defrosting Entry Temp	-17~0°C	1°C
P4	Maximum Defrosting Running Time	1 ~ 12 min	1 min
P5	Defrosting Exit Temp	8~30°C	1°C

2.3.4. Running status checking

Press  for 5 seconds, enter into "Running status checking", and the screen alternately shows status point "C0" and its corresponding value. Check all status points and their corresponding value through  or , Press  to quit "running status checking" mode.

Running status checking list

Symbol	Content	Unit
C0	Inlet water temp.	°C / °F
C1	Outlet water temp.	°C / °F
C2	Ambient temp.	°C / °F
C3	Exhaust temp.	°C / °F
C4	Outer coil pipe temp. (Evaporator)	°C / °F
C5	Gas return temp.	°C / °F
C6	Inner coil pipe temp. (Titanium heat exchanger)	°C / °F
C9	Cooling plate temp.	°C / °F
C10	Electronic expansion valve opening	P
C11	DC fan speed	(r/min)

2.4. Daily maintenance and winterizing

2.4.1. Daily Maintenance

- ⚠** Please don't forget to cut off power supply of the heat pump
- Please clean the heat pump with household detergents or clean water, NEVER use gasoline, thinners or any similar fuel.
- Check bolts, cables and connections regularly.

2.4.2. Winterizing

In winter season when you don't swim, please cut off power supply and drain water out of the heat pump. When using the heat pump under 2°C / 36°F, make sure there is always water flow.

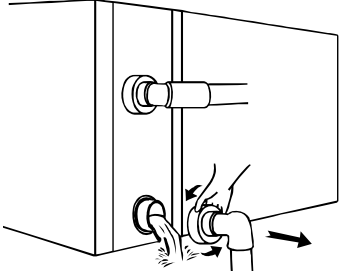

⚠ Attention

Unscrew the lower water union of inlet pipe to let the water flow out. When the water in machine freezes in winter season, the titanium heat exchanger may be damaged.

3. TECHNICAL SPECIFICATION

Model	X20-09	X20-11	X20-14	X20-16	X20-18	X20-22
Advised pool volume (m ³)	18~35	25~40	30~50	35~60	40~65	45~75
Working air temp (°C)	-20 ~43					
Performance Condition: Air 26°C , Water 26°C , Humidity 80%						
Heating capacity (kW) in Turbo mode	9.5	11.5	14.0	16.5	18.5	22.0
Heating capacity (kW) in Smart mode	8.0	9.0	12.0	14.0	15.4	18.0
COP	19.5~7.3	20.2~7.6	20.0~7.8	20.5~7.4	19.6~7.2	21~7.4
COP at 50% capacity	14.6	15.0	15.2	15.1	14.8	15.3
COP at 20% capacity	19.5	20.2	20.0	20.5	19.6	21.0
Performance Condition: Air 15°C , Water 26°C , Humidity 70%						
Heating capacity (kW) in Turbo mode	6.5	7.7	9.2	11.0	12.5	14.8
Heating capacity (kW) in Smart mode	5.4	6.4	7.5	9.2	10.4	12.5
COP	8.0~5.2	8.7~5.6	8.1~5.4	9.0~5.3	8.2~5.1	9.0~5.4
COP at 50% capacity	7.2	7.5	7.3	7.7	7.3	7.6
COP at 20% capacity	8.0	8.7	8.1	9.0	8.2	9.0
Performance Condition: Air 7°C , Water 26°C , Humidity 90%						
Heating capacity (kW) in Turbo mode	5.0	6.6	7.4	9.2	10.5	11.8
COP	7.1~4.5	7.2~4.9	7.1~4.6	7.2~4.6	7.0~4.4	7.4~4.5
Sound pressure at 1m dB(A)	36.6~43.4	37.7~44.8	37.8~45.9	41.0~46.7	41.5~47.3	41.9~49.5
Sound pressure of 50% capacity at 1m dB(A)	37.6	38.8	40.3	42.7	42.5	43.3
Sound pressure at 10m dB(A)	16.6~23.4	17.7~24.8	17.8~25.9	21.0~26.7	21.5~27.3	21.9~29.5
Power supply	230V /1 Ph / 50Hz					
Rated input power (kW) at air 15°C	0.14~1.25	0.15~1.38	0.19~1.7	0.20~2.08	0.25~2.45	0.27~2.74
Rated input current (A) at air 15°C	0.61~5.43	0.65~6.00	0.83~7.39	0.87~9.04	1.09~10.65	1.17~11.9
Advised water flux (m ³ /h)	2~4	2~4	3~4	4~6	4~6	6.5~8.5
Water pipe in-out Spec (mm)	50					
Net Dimension L × W × H (mm)	910×432× 660	910×432× 660	945×432× 660	1045×432× 660	1045×432× 660	1195×432× 760
Net Weight (kg)	63	63	65	72	73	82

FOR USERS

Model	X20-26	X20-26T	X20-32	X20-32T	X20-40T
Advised pool volume (m ³)	55~90	55~90	65~105	65~105	75~120
Working air temp (°C)	-20 ~43				
Performance Condition: Air 26°C, Water 26°C Humidity 80%					
Heating capacity (kW) in Turbo mode	26.5	26.5	32.0	32.0	40.0
Heating capacity (kW) in Smart mode	22.5	22.5	27.5	27.5	35.0
COP	20.7~7.5	20.5~7.4	20.0~7.3	20.0~7.3	20.1~7.3
COP at 50% capacity	15.2	15.2	15.1	15.1	15.0
COP at 20% capacity	20.7	20.5	20.0	20.0	20.1
Performance Condition: Air 15°C, Water 26°C, Humidity 70%					
Heating capacity (kW) in Turbo mode	18.2	18.2	22.3	22.3	28.5
Heating capacity (kW) in Smart mode	15.0	15.0	18.5	18.5	24.0
COP	9.5~5.5	9.3~5.5	8.3~5.4	8.3~5.4	8.2~5.0
COP at 50% capacity	8.0	8.0	7.6	7.6	7.5
COP at 20% capacity	9.5	9.3	8.3	8.3	8.2
Performance Condition: Air 7°C, Water 26°C, Humidity 90%					
Heating capacity (kW) in Turbo mode	15.5	15.5	17.8	17.8	22.8
COP	7.3~4.7	7.2~4.5	7.3~4.7	7.0~4.5	7.0~4.3
Sound pressure at 1m dB(A)	39.7~49.8	39.7~49.8	42.1~50.3	42.1~50.3	41.5~50.5
Sound pressure of 50% capacity at 1m dB(A)	43.1	43.1	45.2	45.2	42.5
Sound pressure at 10m dB(A)	19.7~29.8	19.7~29.8	22.1~30.3	22.1~30.3	21.5~30.5
Power supply	230V /1 Ph / 50Hz	400V /3 Ph / 50Hz	230V /1 Ph / 50Hz	400V /3 Ph / 50Hz	
Rated input power (kW) at air 15°C	0.32~3.31	0.32~3.31	0.46~4.1	0.46~4.1	0.60~5.7
Rated input current (A) at air 15°C	1.39~14.4	0.46~4.78	2.01~17.8	0.66~5.91	0.87~8.22
Advised water flux (m ³ /h)	8~10	8~10	10~12	10~12	12~18
Water pipe in-out Spec (mm)	50				
Net Dimension L × W × H (mm)	1072×541× 956	1072×541× 956	1074×539× 947	1074×539× 947	1260×539× 947
Net Weight (kg)	100	111	122	132	147

- The values indicated are valid under ideal conditions: Pool covered with an isothermal cover, filtration system running at least 15 hours a day.
- Related parameters subject to adjustment periodically for technical improvement without further notice. For details please refer to nameplate.

1. TRANSPORTATION

1.1. When storing or moving the heat pump, the heat pump should be at the upright position.

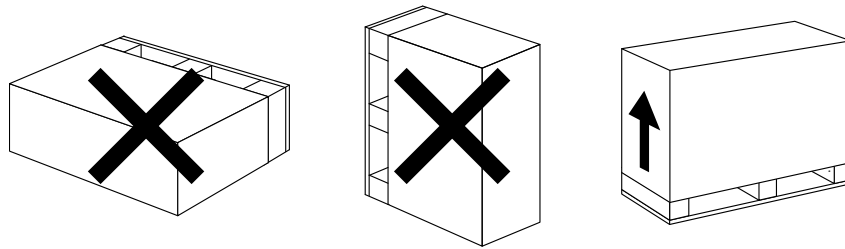

1.2. When moving the heat pump, do not lift the water unions since the titanium heat exchanger inside the heat pump will be damaged.

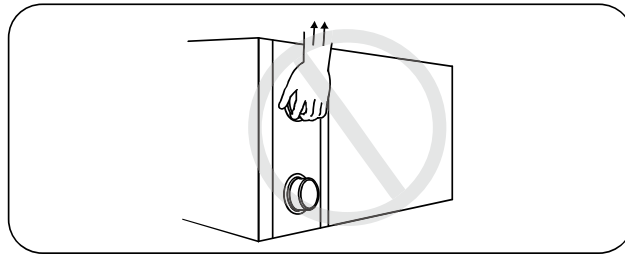

2. INSTALLATION AND MAINTENANCE

⚠ The heat pump must be installed by a professional team. The users are not qualified to install by themselves, otherwise the heat pump might be damaged and risky for users' safety.

2.1. Notice before installation

2.1.1. The inlet and outlet water unions can't bear the weight of soft pipes. The heat pump must be connected with hard pipes!

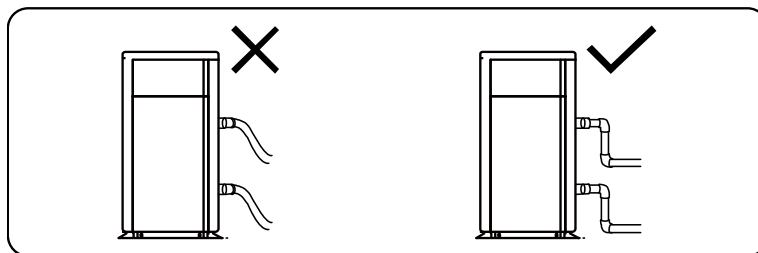

2.1.2. In order to guarantee the heating efficiency, the water pipe length should be $\leq 10\text{m}$ between the pool and the heat pump.

2.2. Installation instruction

2.2.1. Location and size

⚠ To avoid air recirculation, the heat pump should be installed in a place with good ventilation or should reserve sufficient space for installation and maintenance. Please refer to the schema below:

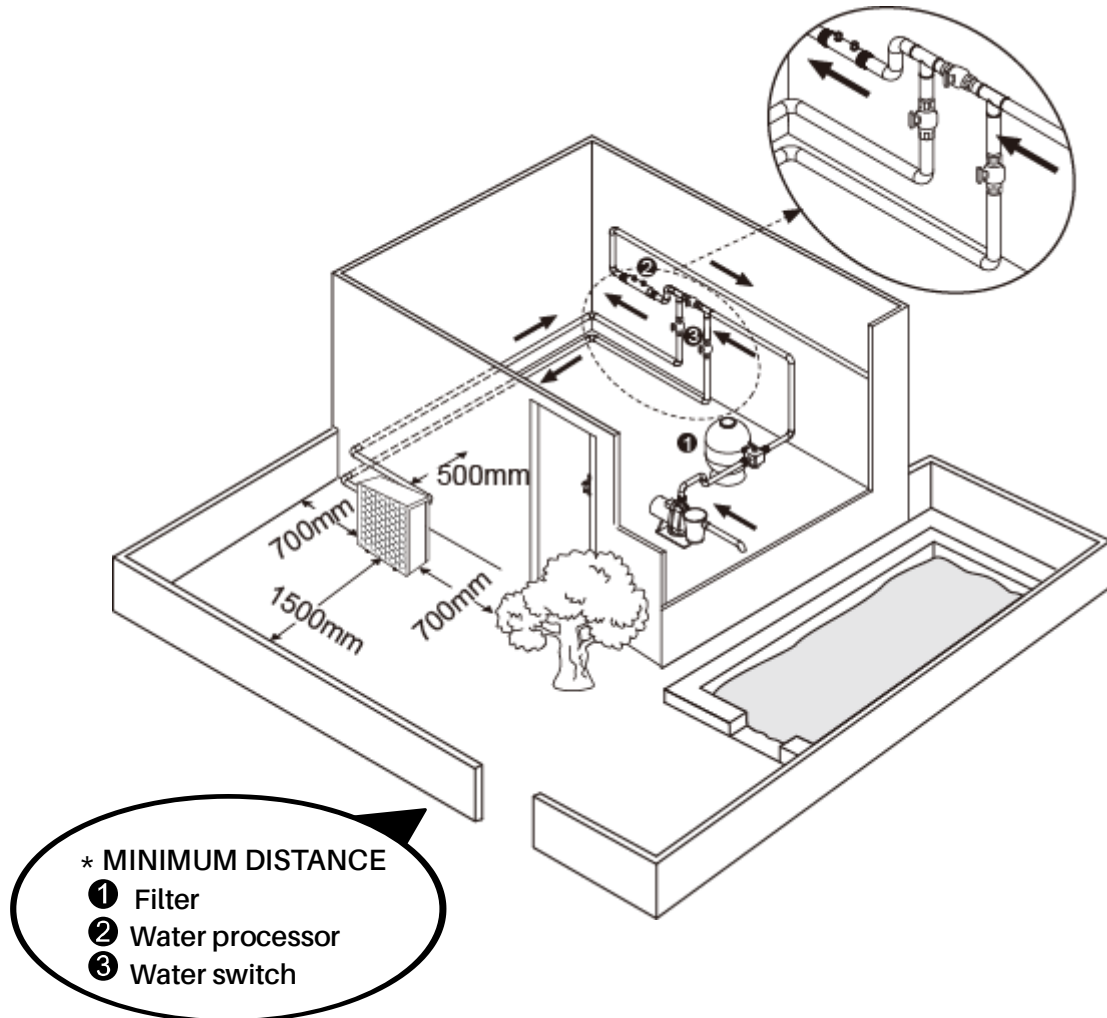

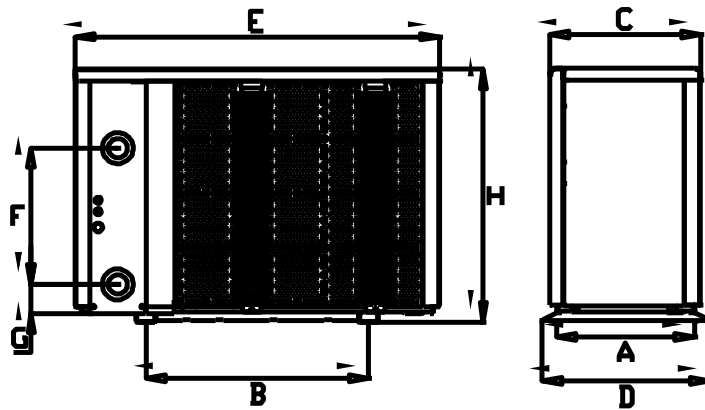

UNIT=MM		A	B	C	D	E	F	G	H
MODEL	X20-09	402	539	389	432	910	300	73	660
	X20-11	402	539	389	432	910	300	73	660
	X20-14	402	574	389	432	945	340	73	660
	X20-16	402	674	389	432	1045	370	73	660
	X20-18	402	674	389	432	1045	380	73	660
	X20-22	402	824	389	432	1195	470	73	760
	X20-26	511	700	498	536	1072	550	73	956
	X20-26T	511	700	498	536	1072	550	73	956
	X20-32	511	891	498	536	1264	570	73	956
	X20-32T	511	891	498	536	1264	570	73	956
	X20-40T	511	991	498	536	1364	670	73	956

※ Above data is subject to modification without notice.

2.2.2. Heat pump installation.

- The frame must be fixed by bolts (M10) to concrete foundation or brackets. The concrete foundation must be solid; the bracket must be strong enough and anti-rust treated;
- The heat pump needs a water pump (Supplied by the user). The recommended pump specification-flux: refer to Technical Parameter, Max. lift $\geq 10\text{m}$
- When the heat pump is running, there will be condensation water discharged from the bottom, please pay attention to it. Please insert the drainage tube (accessory) into the hole and clip it well, then connect a pipe to drain off the condensation water.

2.2.3. Wiring and protecting devices and cable specification

- Connect to appropriate power supply, the voltage should comply with the rated voltage of the products.
- Well earth the heat pump.
- Wiring must be connected by a professional technician according to the circuit diagram.
- Set breaker or fuse according to the local code (leakage operating current $\leq 30\text{mA}$).
- The layout of power cable and signal cable should be orderly and not affecting each other. Considering the environmental conditions (ambient temperature, direct sunlight, rain, grid voltage, cable length, etc.), the cross-sectional area of the cable can be appropriately increased.

⚠ 1. Connecting your power wire

- ✧ Please use cross screwdriver to take off the 2 screws at the bottom of the right side panel. Take off the lower half of the panel.
- ✧ Unscrew the 4 screws on the cover of the electrical box.
- ✧ Connect the terminals according to the electrical diagram.

⚠ 2. Wiring diagram

A. For power supply: 230V 50Hz

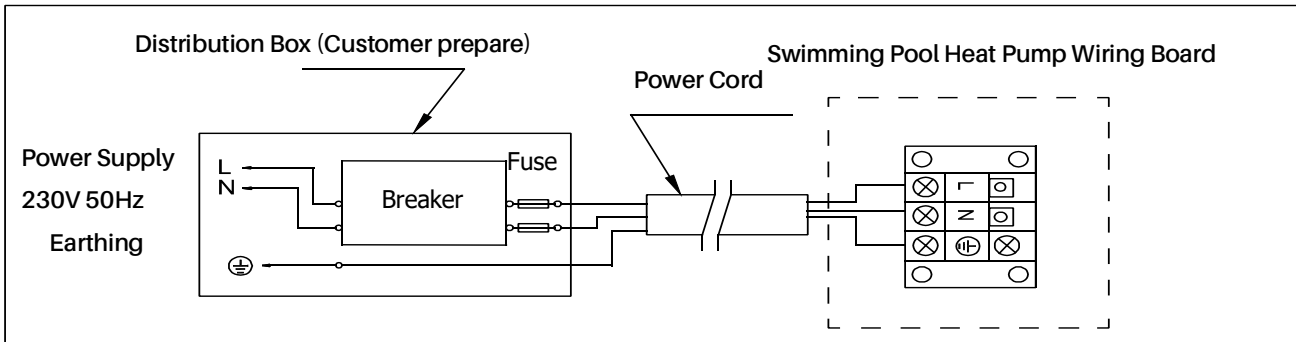

B. For power supply: 400V 50Hz

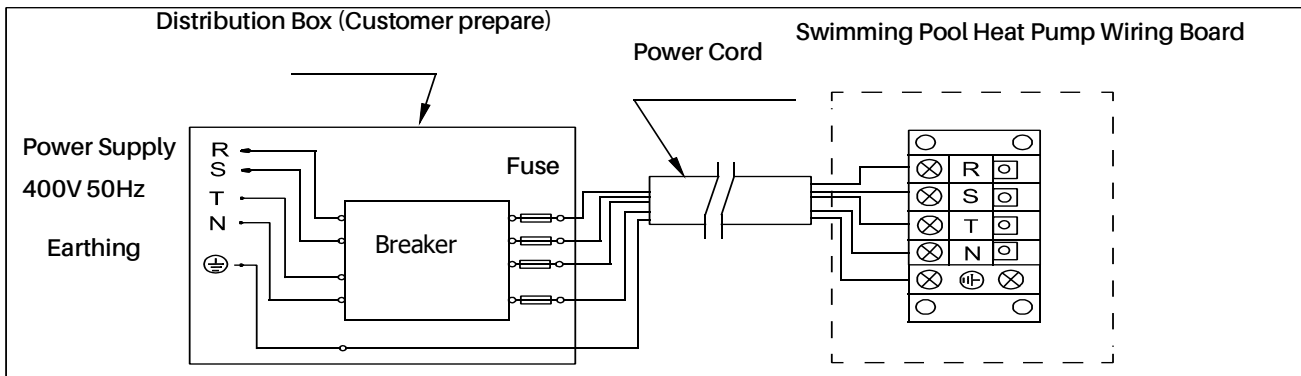

NOTE:

 Must be hard wired, no plug allowed.

- For your safe use in winter, it's strongly recommended to equip heating priority function.
- For the detailed wiring diagram, please refer to Appendix 1.

3. Options for protecting devices and cable specification

MODEL		X20-09	X20-11	X20-14	X20-16	X20-18	X20-22
Breaker	Rated Current (A)	11.0	12.0	15.0	19.0	20.0	22.5
	Rated Residual Action Current (mA)	30	30	30	30	30	30
Max input current (A)		9.0	10.0	12.5	16.0	16.5	18.5
Fuse (A)		11.0	12.0	15.0	19.0	20.0	22.5
Power Cord (mm ²)		3×2.5	3×2.5	3×2.5	3×2.5	3×2.5	3×4
Signal cable (mm ²)		3×0.5	3×0.5	3×0.5	3×0.5	3×0.5	3×0.5

MODEL		X20-26	X20-26T	X20-32	X20-32T	X20-40T
Breaker	Rated Current (A)	24.5	10.0	28.5	11.3	15.0
	Rated Residual Action Current (mA)	30	30	30	30	30
Max input current (A)		20.5	8.0	24.0	9.4	12.5
Fuse (A)		24.5	10.0	28.5	11.3	15.0
Power Cord (mm ²)		3×4	5×2.5	3×6	5×2.5	5×2.5
Signal cable (mm ²)		3×0.5	3×0.5	3×0.5	3×0.5	3×0.5

NOTE: The above data is adapted to power cord ≤ 5m. If power cord is >5m, wire diameter must be increased. The signal cable can be extended to 50m at most.

2.3. Trial after installation

 Please check all the wirings carefully before turning on the heat pump.

2.3.1. Inspection before use

- Check installation of the whole heat pump and the pipe connections according to the pipe connecting drawing;
- Check the electric wiring according to the electrical wiring diagram and earthing connection;
- Make sure that the main power is well connected;
- Check if there is any obstacle in front of the air inlet and outlet of the heat pump

2.3.2. Trial

- Water pump should start before the heat pump, and turn off after the heat pump for long life.
- After the water pump starts, please make sure no leakage of water. Then power on and

FOR INSTALLERS AND PROFESSIONALS

press the ON/OFF button of the heat pump, and set desired temperature.

- In order to protect the heat pump, the heat pump is equipped with start delay function. When starting the heat pump, the fan will start to run in 3 minutes, in another 30 seconds, the compressor will start to run.
- After pool heat pump starts up, check for any abnormal noise from the heat pump.
- Check the temperature setting.

2.4. Maintenance and winterizing

2.4.1. Maintenance

! The maintenance should be carried out once per year by qualified professional technician.

- Cut off power supply of the heat pump before cleaning, examination and repairing . Do not touch the electronic components until the LED indication lights on PC board turn off.

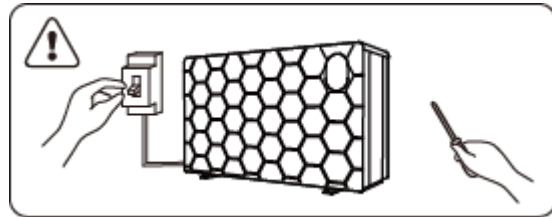

- Please clean the evaporator with household detergents or clean water, NEVER use gasoline, thinners or any similar fuel.
- Check bolts, cables and connections regularly.

2.4.2. Winterizing

In winter season when you don't swim, please cut off power supply and drain water out of the heat pump. When using the heat pump under 2°C / 36°F, make sure there is always water flow.

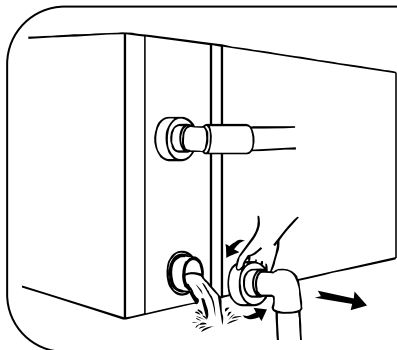

! Attention

Unscrew the lower water union of inlet pipe to let the water flow out. When the water in machine freezes in winter season, the titanium heat exchanger may be damaged.

3. TROUBLE SHOOTING FOR COMMON FAULTS

FAILURE	REASON	SOLUTION
Heat pump doesn't run	No power	Wait until the power recovers
	Power switch is off	Switch on the power
	Fuse burned	Check and change the fuse
	The breaker is off	Check and turn on the breaker
Fan running but with insufficient heating	evaporator blocked	Remove the obstacles
	Air outlet blocked	Remove the obstacles
	3 minutes start delay	Wait patiently
Display normal, but no heating	Set temp. too low	Set proper heating temp.
	3 minutes start delay	Wait patiently
If above solutions don't work, please contact your installer with detailed information and your model number. Don't try to repair it yourself.		

ATTENTION! Please don't try to repair the heat pump by yourself to avoid any risk.

4. FAILURE CODE

NO.	DISPLAY	NOT FAILURE DESCRIPTION
1	E3	No water protection
2	E5	Power supply exceeds operation range
3	E6	Excessive temp difference between inlet and outlet water (Insufficient water flow protection)
4	Eb	Ambient temperature too high or too low protection
5	Ed	Anti-freezing reminder
6	OFF	Customer Control Switch DIN2 Disconnect
NO.	Display	Failure description
1	E1	High pressure protection
2	E2	Low pressure protection
3	E4	Phases lack protection (three phase model only)
4	E7	Water outlet temp too high or too low protection
5	E8	High exhaust temp protection
6	EA	Evaporator overheat protection (only at cooling mode)
7	P0	Controller communication failure
8	P1	Water inlet temp sensor failure
9	P2	Water outlet temp sensor failure
10	P3	Gas exhaust temp sensor failure
11	P4	Heating (Evaporator) coil pipe temp sensor
12	P5	Gas return temp sensor failure
13	P6	Cooling (Titanium heat exchanger) coil pipe temp sensor
14	P7	Ambient temp sensor failure
15	P8	Cooling plate sensor failure
16	P9	Current sensor failure
17	PA	Restart memory failure
18	F1	Compressor drive module failure
19	F2	PFC module failure
20	F3	Compressor start failure
21	F4	Compressor running failure
22	F5	Inverter board over current protection
23	F6	Inverter board overheat protection
24	F7	Current protection
25	F8	Cooling plate overheat protection
26	F9	Fan motor failure
27	Fb	Capacitor no charging protection
28	FA	PFC module over current protection
29	8888	Communication failure

APPENDIX 1: HEATING PRIORITY WIRING DIAGRAM (OPTIONAL)

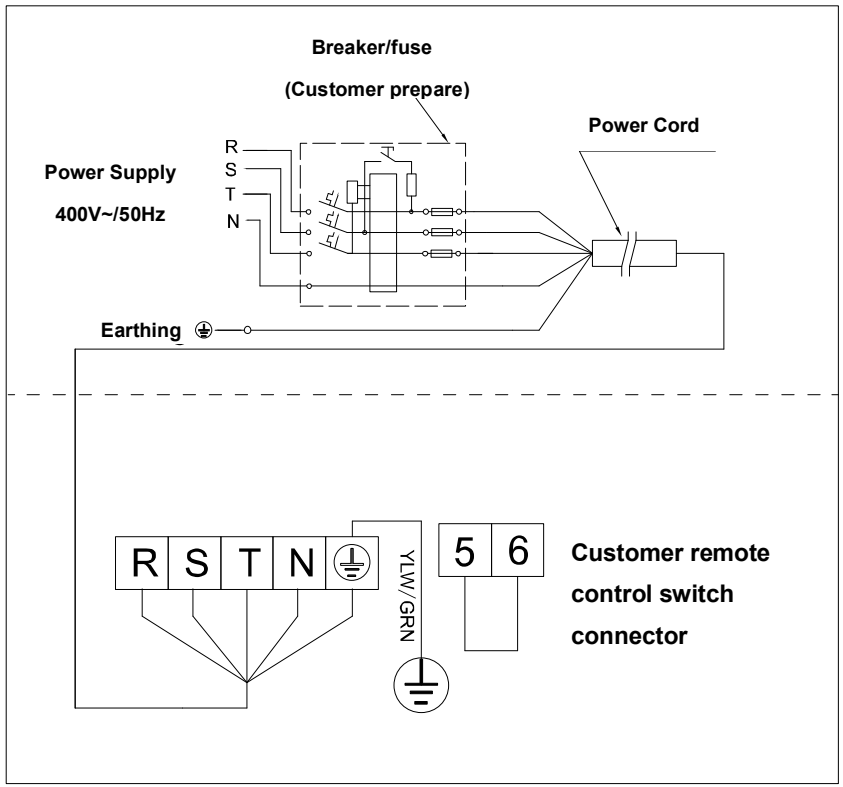
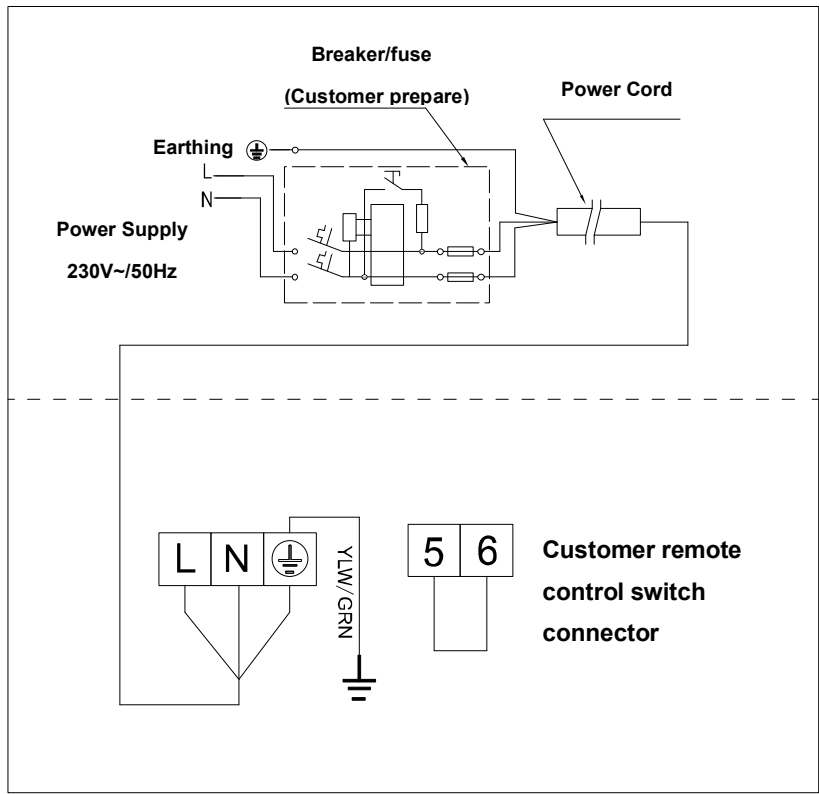

5. WI-FI SETTING

5.1. APP Download



Android Mobile please download from



iPhone please download from



5.2. Account registration

a) Registration by Cell phone number/Email

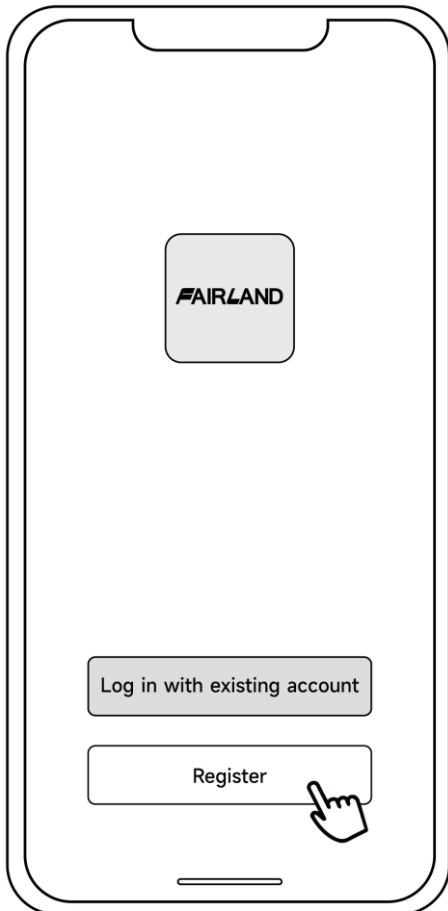

b) Cell phone number registration



5.3. Create family

Please set a name for the family and choose the room of the device.

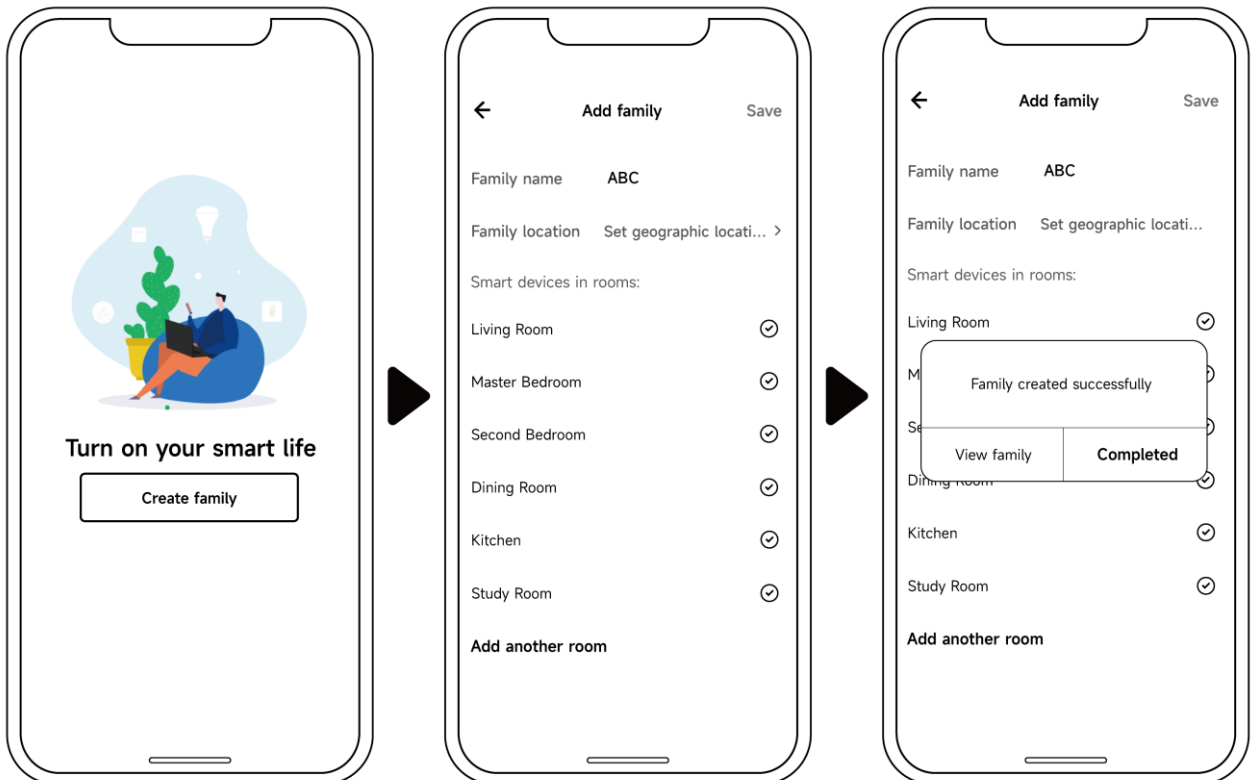



5.4. Three methods of device binding

Please connect your phone to the Wi-Fi network first.



5.4.1. Auto Discovery (Bluetooth)

- a) Please make sure the Bluetooth function is enabled on your phone.
- b) Press  for 3 seconds after the screen unlock,  will be flashing rapidly to enter Wi-Fi binding status.
- c) Click "Add Device", wait for the app to search for the device and then click "add", then follow the instructions below to finish the device binding.





Note:

1. It will take some time to scan, please be patient.
2. Only Wi-Fi modules with Bluetooth functions can use this method.

5.4.2. EZ Mode (Easy-connect)

a) Activate the Wi-Fi module

b) Press  for 3 seconds after the screen unlocks,  will be flashing rapidly to enter Wi-Fi binding status.

c) Click "Add device", and follow the instructions below to finish binding.  display on the screen once the Wi-Fi connection success.

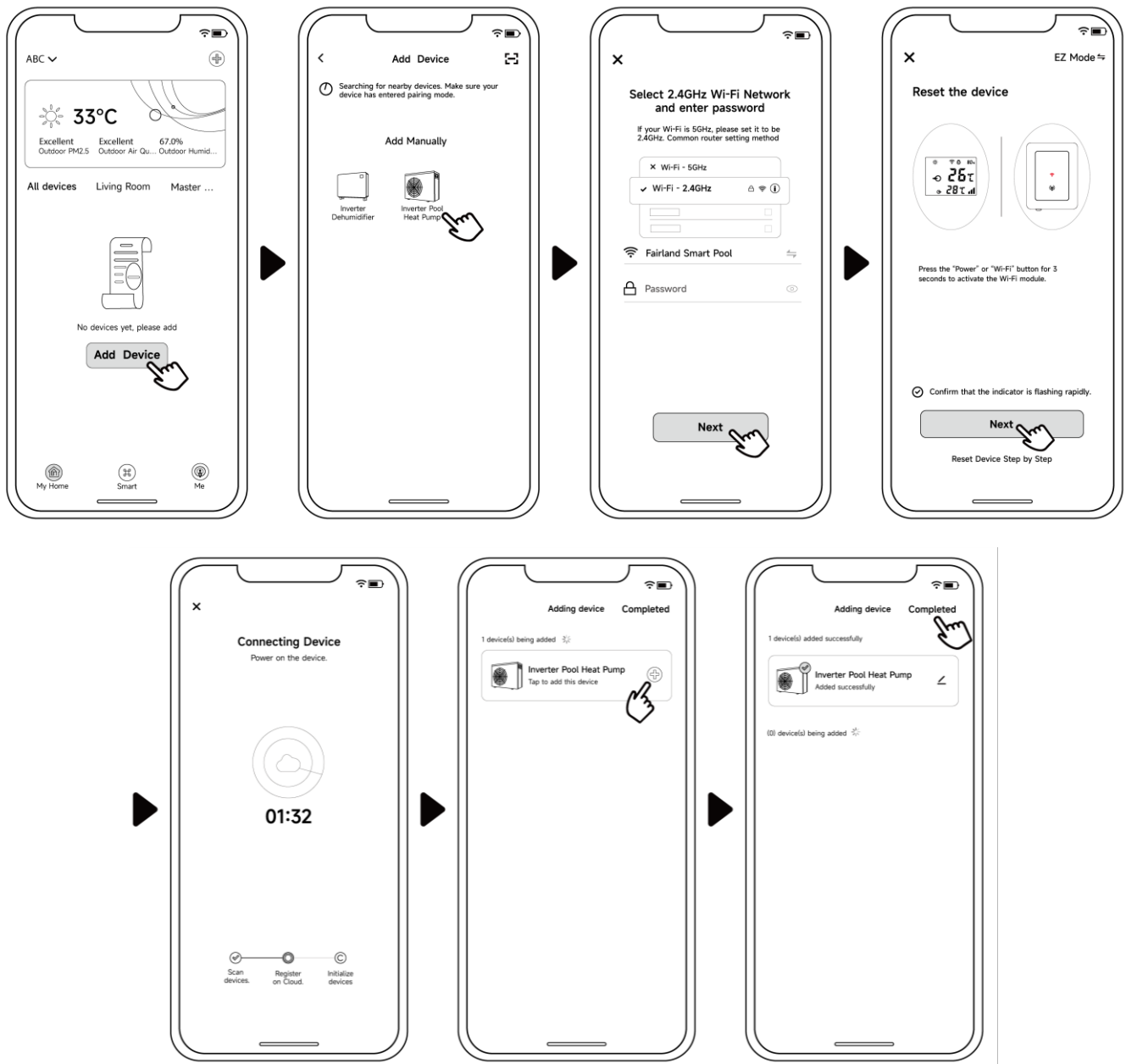



Note:

1. After allowing the APP to locate, it can read the Wi-Fi name automatically.
2. Before clicking "Completed", you need to click "+" once.

5.4.3. AP Mode

Activate Wi-Fi module

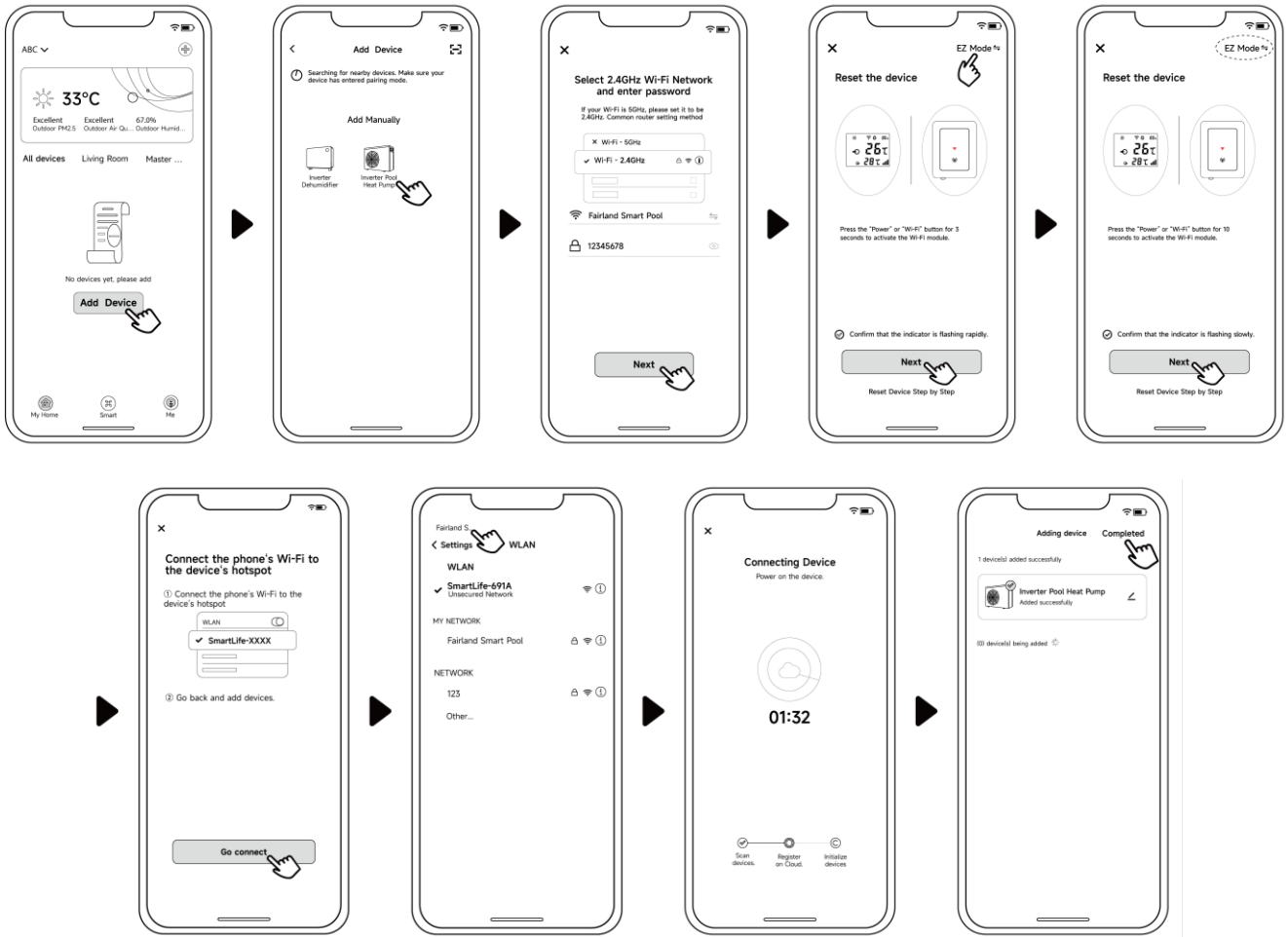

- a) Press  for 10 seconds after the screen unlock,  will be flashing slowly to enter Wi-Fi binding status.
- b) Click "Add device", and follow the instructions below to finish binding.  display on the screen once the Wi-Fi connection success.



Note: If it doesn't jump automatically, click "Confirm hotspot connection, next".

5.4.4. If connect fails, please make sure your network name and password are correct. And your router, mobile phone and device are as close as possible.

5.4.5. Wi-Fi rebinding (When Wi-Fi password changes or network configuration changes)

Press  for 10 seconds,  will be flashing slowly for 60 seconds. Then  will be off. The original binding will be removed. Follow steps above for rebinding.

Remarks: Please make sure the router is configured at 2.4 GHz.

5.5. Operation instructions

The following instructions are for heat pumps with heating function only.

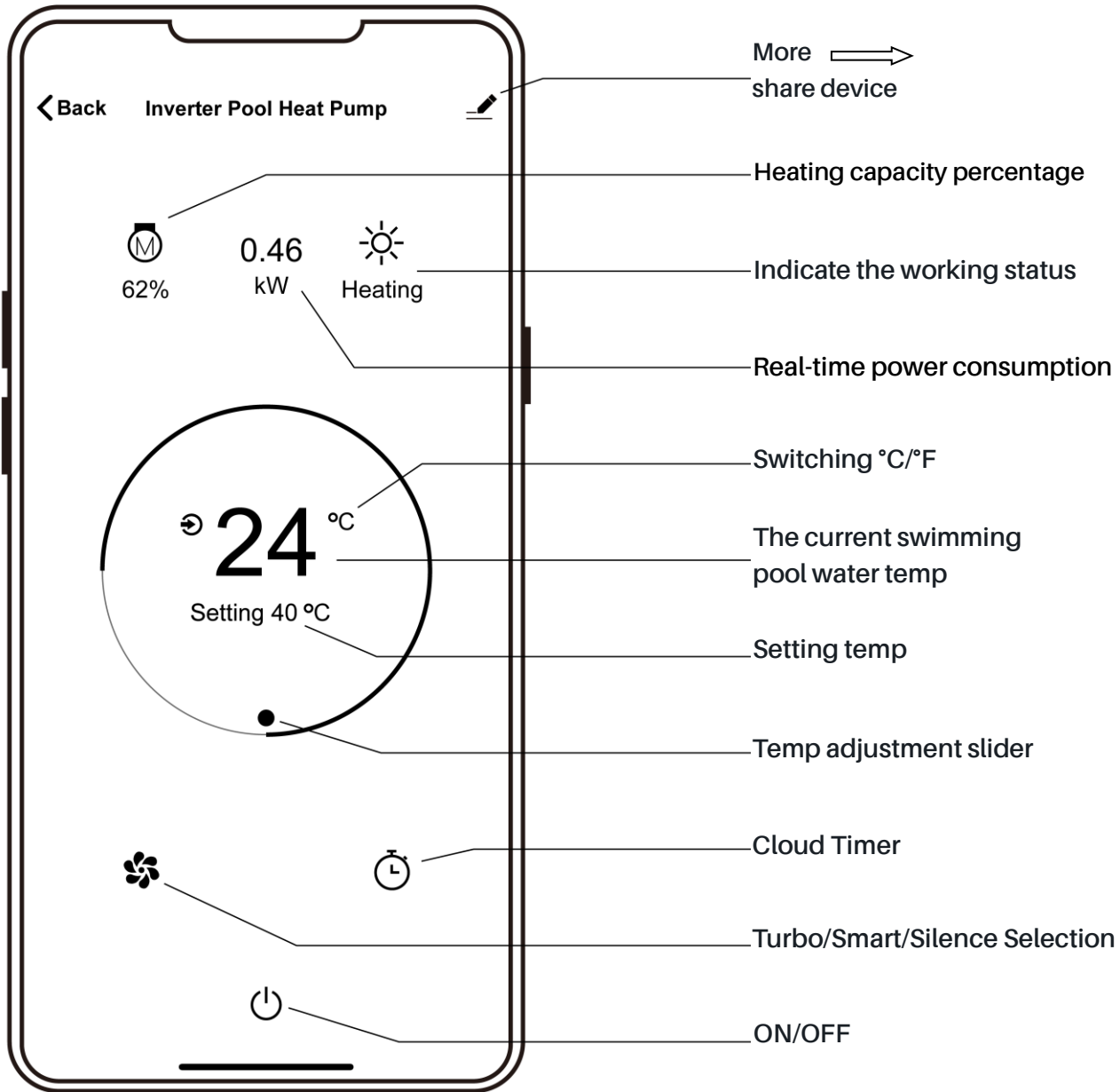

5.6. Share devices with your family members

After binding, if your family members also want to control the device.

Please let your family members register the APP first, and then the administrator can operate as below (The following pictures are for reference only):

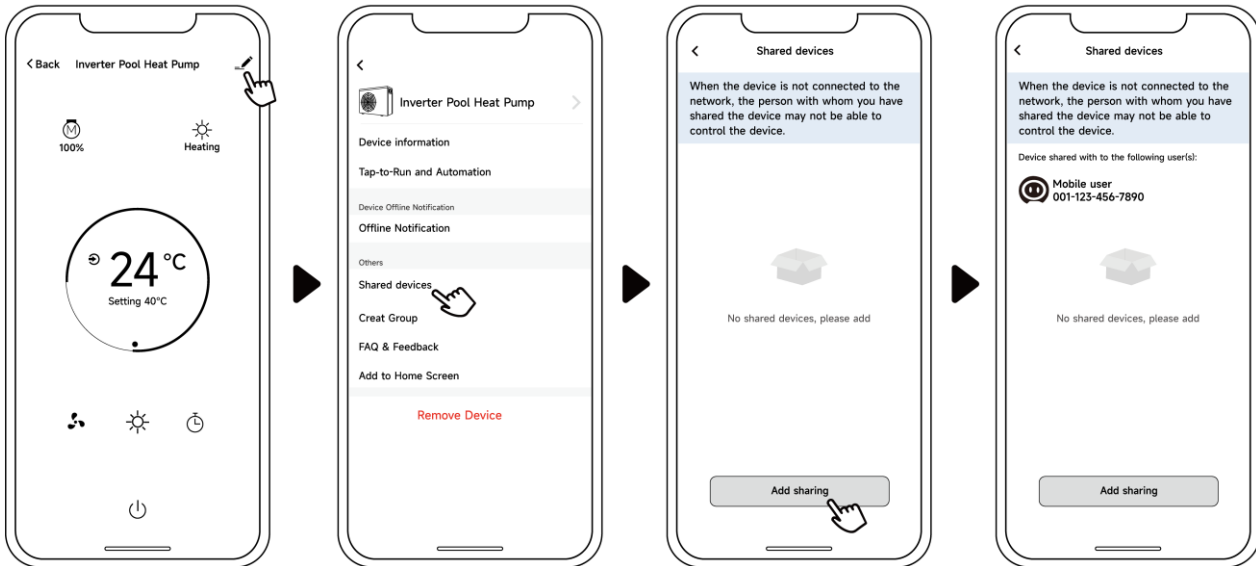

Then your family members will see this heat pump once they log in to the APP.

- Notice: 1. The weather forecast is just for reference.
2. APP is subject to update without notice.

The factory reserves the final interpretation right.
And keep the right to stop or change product specification and design without prior notice at any time, no need to bear the resulting obligations.

CE Declaration of conformity

The manufacturer declares that the following product complies with the appropriate basic safety according to the CE directives based on its design and type

Product Description: swimming pool heat pump

Manufacturer's model Ref	Customer's model Ref.
X20-09	X20-09
X20-11	X20-11
X20-14	X20-14
X20-16	X20-16
X20-18	X20-18
X20-22	X20-22
X20-26	X20-26
X20-26T	X20-26T
X20-32	X20-32
X20-32T	X20-32T
X20-40T	X20-40T

Manufacturer declares that above designated product is designed according to bellow Directives.

Applicable EC Directives:

Low voltage Directive (2014 /35/EU)

EC Council Directive (2014/30/EU)

FAIRLAND ELECTRIC CO., LTD.
2021-8-31

Thank you for choosing Fairland TurboSilence Inverter.



Version: G02XPr32-1

welldana[®]
● ● ●